

# Digital 4K Video Camera Recorder

## Operating Guide



### “Help Guide” (Web manual)

Refer to “Help Guide” for in-depth instructions on the many functions of the camera.

[http://rd1.sony.net/help/cam/1630/h\\_zz/](http://rd1.sony.net/help/cam/1630/h_zz/)

Getting started

Recording/Playback

Saving images

Customizing your  
camcorder

Others

**HANDYCAM®**

**AVCHD**  
Progressive

**XAVC S**

**4K**

**HDMI™**  
REGISTERED TRADEMARK

**InfoLITHIUM V**  
SERIES

**MEMORY STICK**

**XC**

**N**

# Read this first

Before operating the unit, please read this manual thoroughly, and retain it for future reference.

## Owner's Record

The model and serial numbers are located on the bottom. Record the serial number in the space provided below. Refer to these numbers whenever you call your Sony dealer regarding this product.

Model No. FDR- \_\_\_\_\_

Serial No. \_\_\_\_\_

## WARNING

**To reduce the risk of fire or electric shock,**

**1) do not expose the unit to rain or moisture.**

**2) do not place objects filled with liquids, such as vases, on the apparatus.**

**Do not expose the batteries to excessive heat such as sunshine, fire or the like.**

# IMPORTANT SAFETY INSTRUCTIONS

## SAVE THESE INSTRUCTIONS. DANGER - TO REDUCE THE RISK OF FIRE OR ELECTRIC SHOCK, CAREFULLY FOLLOW THESE INSTRUCTIONS.

- Read these instructions.
- Keep these instructions.
- Heed all warnings.
- Follow all instructions.
- Do not use this apparatus near water.
- Clean only with dry cloth.
- Do not block any ventilation openings. Install in accordance with the manufacturer's instructions.
- Do not install near any heat sources such as radiators, heat registers, stoves, or other apparatus (including amplifiers) that produce heat.
- Do not defeat the safety purpose of the polarized or grounding-type plug. A polarized plug has two blades with one wider than the other. A grounding type plug has two blades and a third grounding prong. The wide blade or the third prong are provided for your safety. If the provided plug does not fit into your outlet, consult an electrician

for replacement of the obsolete outlet.

- Protect the power cord from being walked on or pinched particularly at plugs, convenience receptacles, and the point where they exit from the apparatus.
- Only use attachments/accessories specified by the manufacturer.
- Use only with the cart, stand, tripod, bracket, or table specified by the manufacturer, or sold with the apparatus. When a cart is used, use caution when moving the cart/apparatus combination to avoid injury from tip-over.



- Unplug this apparatus during lightning storms or when unused for long periods of time.
- Refer all servicing to qualified service personnel. Servicing is required when the apparatus has been damaged in any way, such as power-supply cord or plug is damaged, liquid has been spilled or objects have fallen into the apparatus, the apparatus has been exposed to rain or moisture, does not operate normally, or has been dropped.
- If the shape of the plug does not fit the power outlet, use an attachment plug adaptor of the proper configuration for the power outlet.

## Representative plug of power supply cord of countries/regions around the world.



A Type  
(American  
Type)



B Type  
(British  
Type)



BF Type  
(British  
Type)



B3 Type  
(British  
Type)



C Type  
(CEE  
Type)



SE Type  
(CEE  
Type)



O Type  
(Ocean  
Type)

The representative supply voltage and plug type are described in this chart. Depend on an area, Different type of plug and supply voltage are used.

Attention: Power cord meeting demands from each country shall be used.

- For only the United States

Use a supplied power cord.

### Europe

Countries/regions	Voltage	Frequency (Hz)	Plug type
Austria	230	50	C
Belgium	230	50	C
Czech	220	50	C
Denmark	230	50	C
Finland	230	50	C
France	230	50	C
Germany	230	50	C
Greece	220	50	C
Hungary	220	50	C
Iceland	230	50	C
Ireland	230	50	C/BF
Italy	220	50	C
Luxemburg	230	50	C
Netherlands	230	50	C
Norway	230	50	C
Poland	220	50	C
Portugal	230	50	C
Romania	220	50	C
Russia	220	50	C
Slovak	220	50	C
Spain	127/230	50	C
Sweden	230	50	C
Switzerland	230	50	C
UK	240	50	BF

## Asia

Countries/regions	Voltage	Frequency (Hz)	Plug type
China	220	50	A
Hong Kong	200/220	50	BF
India	230/240	50	C
Indonesia	127/230	50	C
Japan	100	50/60	A
Korea (rep)	220	60	C
Malaysia	240	50	BF
Philippines	220/230	60	A/C
Singapore	230	50	BF
Taiwan	110	60	A
Thailand	220	50	C/BF
Vietnam	220	50	A/C

## Oceania

Countries/regions	Voltage	Frequency (Hz)	Plug type
Australia	240	50	O
New Zealand	230/240	50	O

## North America

Countries/regions	Voltage	Frequency (Hz)	Plug type
Canada	120	60	A
USA	120	60	A

## Central America

Countries/regions	Voltage	Frequency (Hz)	Plug type
Bahamas	120/240	60	A
Costa Rica	110	60	A
Cuba	110/220	60	A/C
Dominican (rep)	110	60	A
El Salvador	110	60	A
Guatemala	120	60	A
Honduras	110	60	A
Jamaica	110	50	A
Mexico	120/127	60	A
Nicaragua	120/240	60	A
Panama	110/220	60	A

## South America

Countries/regions	Voltage	Frequency (Hz)	Plug type
Argentina	220	50	C/BF/O
Brazil	127/220	60	A/C
Chile	220	50	C
Colombia	120	60	A
Peru	220	60	A/C
Venezuela	120	60	A

## Middle East

Countries/regions	Voltage	Frequency (Hz)	Plug type
Iran	220	50	C/BF
Iraq	220	50	C/BF
Israel	230	50	C
Saudi Arabia	127/220	50	A/C/BF
Turkey	220	50	C
UAE	240	50	C/BF

## Africa

Countries/regions	Voltage	Frequency (Hz)	Plug type
Algeria	127/220	50	C
Congo (dem)	220	50	C
Egypt	220	50	C
Ethiopia	220	50	C
Kenya	240	50	C/BF
Nigeria	230	50	C/BF
South Africa	220/230	50	C/BF
Tanzania	230	50	C/BF
Tunisia	220	50	C



## CAUTION

### I Battery pack

If the battery pack is mishandled, the battery pack can burst, cause a fire or even chemical burns. Observe the following cautions.

- Do not disassemble.
- Do not crush and do not expose the battery pack to any shock or force such as hammering, dropping or stepping on it.
- Do not short circuit and do not allow metal objects to come into contact with the battery terminals.
- Do not expose to high temperature above 60°C (140°F) such as in direct sunlight or in a car parked in the sun.
- Do not incinerate or dispose of in fire.
- Do not handle damaged or leaking lithium ion batteries.
- Be sure to charge the battery pack using a genuine Sony battery charger or a device that can charge the battery pack.
- Keep the battery pack out of the reach of small children.
- Keep the battery pack dry.
- Replace only with the same or equivalent type recommended by Sony.
- Dispose of used battery packs promptly as described in the instructions.

### I AC Adaptor

Do not use the AC Adaptor placed in a narrow space, such as between a wall and furniture.

Use the nearby wall outlet (wall socket) when using the AC Adaptor. Disconnect the AC Adaptor from the wall outlet (wall socket) immediately

if any malfunction occurs while using the apparatus.

### I Note on the power cord (mains lead)

The power cord (mains lead) is designed specifically for use with this camcorder only, and should not be used with other electrical equipment.

Even if your camcorder is turned off, AC power source (mains) is still supplied to it while connected to the wall outlet (wall socket) via the AC Adaptor.

## For Customers in the U.S.A. and Canada

### I RECYCLING LITHIUM-ION BATTERIES

Lithium-Ion batteries are recyclable.

You can help preserve our environment by returning your used rechargeable batteries to the collection and recycling location nearest you.

For more information regarding recycling of rechargeable batteries, call toll free 1-800-822-8837, or visit <http://www.call2recycle.org/>

**Caution:** Do not handle damaged or leaking Lithium-Ion batteries.



## For supplied accessories

This device complies with Part 15 of the FCC Rules. Operation is subject to the following two conditions:

(1) This device may not cause harmful interference, and (2) this device must accept any interference received, including interference that may cause undesired operation.

CAN ICES-3 B/NMB-3 B

This equipment complies with FCC/IC radiation exposure limits set forth for an uncontrolled environment and meets the FCC radio frequency (RF) Exposure Guidelines and RSS-102 of the IC radio frequency (RF) Exposure rules. This equipment has very low levels of RF energy that are deemed to comply without testing of specific absorption ratio (SAR).

## For Customers in the U.S.A.

If you have any questions about this product, you may call:  
Sony Customer Information Center  
1-800-222-SONY (7669).  
The number below is for the FCC related matters only.

## Regulatory Information

### Declaration of Conformity

Trade Name: SONY  
Model No.: FDR-AX53  
Responsible Party: Sony  
Electronics Inc.  
Address: 16535 Via Esprillo,  
San Diego, CA 92127  
U.S.A.  
Telephone No.: 858-942-2230

This device complies with Part 15 of the FCC Rules. Operation is subject to the following two conditions: (1) This device may not cause harmful interference, and (2) this device must accept any interference received, including interference that may cause undesired operation.

This equipment must not be co-located or operated in conjunction with any other antenna or transmitter.

### CAUTION

You are cautioned that any changes or modifications not expressly approved in this manual could void your authority to operate this equipment.

### Note:

This equipment has been tested and found to comply with the limits for a Class B digital device, pursuant to Part 15 of the FCC Rules. These limits are designed to provide reasonable protection against harmful interference in a residential installation. This equipment generates, uses, and can radiate radio frequency energy and, if not installed and used in accordance with the instructions, may cause harmful interference to radio communications. However, there is no guarantee that interference will



not occur in a particular installation. If this equipment does cause harmful interference to radio or television reception, which can be determined by turning the equipment off and on, the user is encouraged to try to correct the interference by one or more of the following measures:

- Reorient or relocate the receiving antenna.
- Increase the separation between the equipment and receiver.
- Connect the equipment into an outlet on a circuit different from that to which the receiver is connected.
- Consult the dealer or an experienced radio/TV technician for help.

The supplied interface cable must be used with the equipment in order to comply with the limits for a digital device pursuant to Subpart B of Part 15 of FCC Rules.

## For Customers in Canada

This device complies with Industry Canada licence-exempt RSS standard(s).

Operation is subject to the following two conditions: (1) this device may not cause interference, and (2) this device must accept any interference, including interference that may cause undesired operation of the device.

## For Customers in Europe

### **Notice for the customers in the countries applying EU Directives**

Manufacturer: Sony Corporation, 1-7-1 Konan Minato-ku Tokyo, 108-0075 Japan

For EU product compliance: Sony Belgium, bijkantoor van Sony Europe Limited, Da Vincilaan 7-D1, 1935 Zaventem, Belgium



Hereby, Sony Corporation, declares that this equipment is in compliance with the essential requirements and other relevant provisions of Directive 1999/5/EC. For details, please access the following URL:

<http://www.compliance.sony.de/>

### **Notice**

If static electricity or electromagnetism causes data transfer to discontinue midway (fail), restart the application or disconnect and connect the communication cable (USB, etc.) again.

This product has been tested and found compliant with the limits set out in the EMC regulation for using connection cables shorter than 3 meters (9.8 feet).

The electromagnetic fields at the specific frequencies may influence the picture and sound of this unit.

## Disposal of waste batteries and electrical and electronic equipment (applicable in the European Union and other European countries with separate collection systems)



This symbol on the product, the battery or on the packaging indicates that the product and the battery shall not be

treated as household waste. On certain batteries this symbol might be used in combination with a chemical symbol.

The chemical symbols for mercury (Hg) or lead (Pb) are added if the battery contains more than 0.0005% mercury or 0.004% lead. By ensuring these products and batteries are disposed of correctly, you will help prevent potentially negative consequences for the environment and human health which could otherwise be caused by inappropriate waste handling. The recycling of the materials will help to conserve natural resources.

In case of products that for safety, performance or data integrity reasons require a permanent connection with an incorporated battery, this battery should be replaced by qualified service staff only. To ensure that the battery and the electrical and electronic equipment will be treated properly, hand over these products at end-of-life to the applicable collection point for the recycling of electrical and electronic equipment. For all other batteries, please view the section on how to remove the battery from the product safely. Hand the battery over to the applicable collection point for the recycling of waste batteries. For more detailed

information about recycling of this product or battery, please contact your local Civic Office, your household waste disposal service or the shop where you purchased the product or battery.

## For Customers in Singapore

Complies with  
IDA Standards  
DB00353

## For Customers in U.A.E.

**TRA**  
**REGISTERED No:**  
ER0098751/12  
**DEALER No:**  
DA0073692/11

## For Customers in Malaysia



## For customers in India

**Battery Pack**  
Self Declaration –Conforming to  
IS:16046:2012, R-41022659

This manual describes 1080 60i-compatible devices and 1080 50i-compatible devices.

To check whether your camera is a 1080 60i-compatible device or 1080 50i-compatible device, check for the following marks on the bottom of the camera.

1080 60i-compatible device: 60i  
1080 50i-compatible device: 50i

## Learning more about the camcorder (Help Guide)

Help Guide is an on-line manual. Refer to it for in-depth instructions on the many functions of the camcorder.

Access the Sony support page.

[http://rd1.sony.net/help/cam/1630/h\\_??/](http://rd1.sony.net/help/cam/1630/h_??/)



You will find further information such as the following functions in Help Guide.

- Time-lapse Capture
- TC/UB (Time Code/User Bit)
- Highlight Movie Maker
- Live Streaming
- Multi Camera Control
- Trimming Playback

## Table of Contents

Read this first .....	2
Learning more about the camcorder (Help Guide) .....	11
Selecting the recording format for movies .....	12
<b>Getting started .....</b>	<b>14</b>
Supplied items .....	14
Charging the battery pack .....	15
Turning the power on .....	18
Inserting a memory card .....	19
<b>Recording/Playback ...</b>	<b>22</b>
Recording .....	22
Using the manual adjustment features .....	25
Playback .....	26
Viewing images on a TV .....	29
Viewing images using the built-in projector (FDR-AXP55) ..	33
<b>Saving images .....</b>	<b>34</b>
Importing images to your computer .....	34
Saving images on an external media device .....	35
Using the Wi-Fi function .....	37
<b>Customizing your camcorder .....</b>	<b>42</b>
Using the menus .....	42
<b>Others .....</b>	<b>45</b>
Precautions .....	45
Specifications .....	47
Parts and controls .....	52
Index .....	55



# Selecting the recording format for movies

The camcorder is compatible with the XAVC S format.

## | What is XAVC S?

XAVC S is a recording format that allows high-resolution images, such as 4K, to be highly compressed with MPEG-4 AVC/H.264 and recorded in the MP4 file format. High image quality will be obtained while keeping the data size within a certain level.

### Recording formats available and their features

	XAVC S 4K	XAVC S HD	AVCHD
Pixels	 3840 × 2160	 1920 × 1080	 1920 × 1080
Bit-rate* <sup>1</sup>	60 Mbps/ 100 Mbps	50 Mbps* <sup>2</sup>	Max. 28 Mbps
Features	Records images in 4K. Recording in this format is recommended even if you do not have a 4K TV so you will be able to enjoy the benefits of 4K in the future.	Information volume is greater compared to AVCHD, enabling recording of clearer images.	Compatibility with recording devices other than computers is good.

\*<sup>1</sup> Bit-rate indicates the quantity of data recorded in a certain period.

\*<sup>2</sup> When recording using the high-speed recording function, select from 60 Mbps or 100 Mbps.

## Recording format and the available shooting mode

Recording format	XAVC S 4K	XAVC S HD	AVCHD
Shooting mode	Movie	Movie High Speed REC	Movie Smth Slw REC Golf Shot

- You can change the recording format by selecting **[MENU]** → [Image Quality/Size] → **[File Format]**.

## Storage method

Recording format	Storage method	Image quality stored at	Page
XAVC S 4K	Computer using PlayMemories Home™ software • External media device	XAVC S 4K	34
XAVC S HD		XAVC S HD	34
AVCHD	Computer using PlayMemories Home software	AVCHD	34
	External media device	AVCHD	35

- See the following website for the latest storage environment.  
<http://www.sony.net/>
- You can store images by connecting to a recorder with an analog AV cable (sold separately). Movies are copied with standard definition image quality (page 36).
- You can directly copy images to an external media device with the VMC-UAM2 USB Adaptor Cable (sold separately).

## To transfer images to a smartphone

You can transfer MP4 images to a smartphone connected to the camcorder via Wi-Fi (page 37). MP4 format is good for uploading to the Internet. When [Dual Video REC] is set to [On], the camcorder records movies in XAVC S 4K format, XAVC S HD format, or AVCHD format while recording movies in MP4 format at the same time.

# Supplied items

The numbers in ( ) indicate the supplied quantity.

## All models

- Camcorder (1)
- AC Adaptor (1)

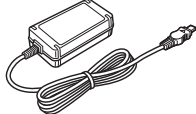

- Power cord (mains lead) (1)

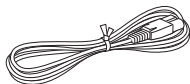

- Micro USB cable (1)

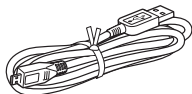

- HDMI cable (1)

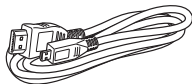

- "Operating Guide" (This manual) (1)
- Rechargeable battery pack NP-FV70 (1)



# Charging the battery pack

- 1 Turn off your camcorder by closing the LCD monitor, retract the viewfinder\*, and attach the battery pack.

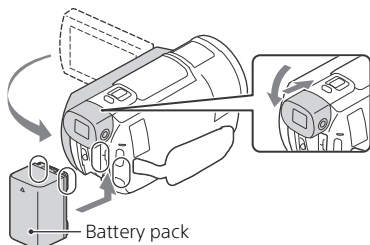

\* Models with the viewfinder (FDR-AX53/AX55/AXP55) only

- 2 Connect the AC Adaptor and the power cord (mains lead) to your camcorder and the wall outlet (wall socket).

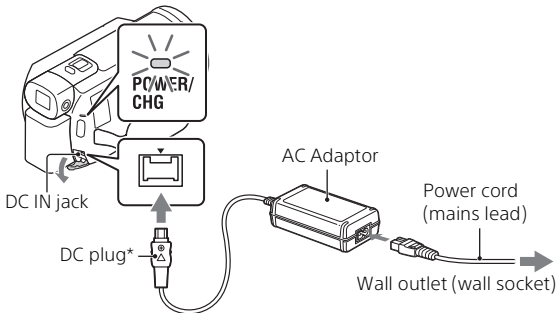

- \* Align the ▲ mark on the DC plug with that on the DC IN jack.
- The POWER/CHG (charge) lamp turns orange.
- The POWER/CHG (charge) lamp turns off when the battery pack is fully charged. Disconnect the AC Adaptor from the DC IN jack of the camcorder.

## Charging the battery using your computer

Turn off your camcorder and connect the Multi/Micro USB Terminal of the camcorder (page 52) to the USB jack of a computer using the micro USB cable.

- Change the setting of your computer so that it would not enter the sleep (hibernation) state before charging your camcorder.





## Estimated time of charging the supplied battery pack (minutes)

Battery pack	AC Adaptor (supplied)	Computer
NP-FV70	205	555

- The charging times are measured when charging an empty battery pack to its full capacity at a room temperature of 25 °C (77 °F).

## Estimated time of recording and playback using the supplied battery pack (minutes)

Battery pack	Recording time		Playback time
	Continuous	Typical	
NP-FV70	150	75	250

- The recording and playback times are measured when using the camcorder at 25 °C (77 °F).
- The recording times are measured when recording movies with the default settings ([ File Format]: [ XAVC S 4K], [ REC Mode]: [60Mbps  ], [Dual Video REC]: [Off]).
- Typical recording time shows the time when you repeat recording start/stop, switching the [Shooting Mode], and zooming.
- The recording time shows the time when recording with the LCD monitor open.

## To use your camcorder connected to the wall outlet (wall socket)

Connect the camcorder to the wall outlet (wall socket) in the same way as "Charging the battery pack."



## | To remove the battery pack

Turn off your camcorder. Slide the BATT (battery) release lever (①) and remove the battery pack (②).

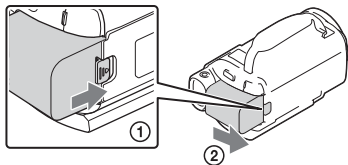

## | To charge the battery pack abroad

You can charge the battery pack in any countries/regions using the AC Adaptor supplied with your camcorder within the AC 100 V - 240 V, 50 Hz/60 Hz range.

- Do not use an electronic voltage transformer.

# Turning the power on

- 1 Open the LCD monitor of your camcorder and turn the power on.

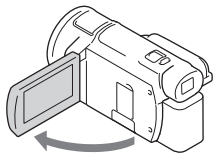

- You can also turn on the camcorder by pulling out the viewfinder (models with the viewfinder (FDR-AX53/AX55/AXP55) only).

- 2 Following the instructions on the LCD monitor, select the language, the geographical area, Daylight Savings or Summer Time, date format, and the date and time.

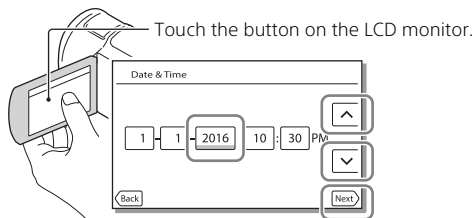

- To go to the next page, touch [Next].
- 
- To turn off the power, close the LCD monitor. If the viewfinder is pulled out, retract it (models with the viewfinder (FDR-AX53/AX55/AXP55) only).
  - To set the date and time again, select **[MENU]** → [Setup] → [🕒 Clock Settings] → [Date & Time Setting]. (In case you haven't used your camcorder for several months)
  - To turn off the operating sound, select **[MENU]** → [Setup] → [🔧 General Settings] → [Beep] → [Off].

# Inserting a memory card

- 1 Open the cover, and insert the memory card until it clicks.

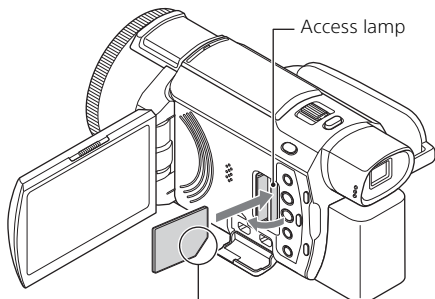

Insert the card with the notched corner in the direction as illustrated.

- The [Preparing image database file. Please wait.] screen appears if you insert a new memory card. Wait until the screen disappears.
- To select a memory card as the recording medium, select **[MENU]** → [Setup] → [Media Settings] → [Media Select] → [Memory Card] (FDR-AX40/AX55/AXP55).
- To eject the memory card, open the cover and lightly push the memory card in once.

## Types of memory card you can use with your camcorder

Select the type of memory card to use with the camcorder referring to the following table.

Memory card	AVCHD	XAVC S
Memory Stick PRO Duo media	○ (Mark 2 only)	-
Memory Stick PRO-HG Duo™ media	○	-
Memory Stick Micro™ (M2) media	○ (Mark 2 only)	-

Memory card	AVCHD	XAVC S
SD memory card	○ <sup>*1</sup>	-
SDHC memory card	○ <sup>*1</sup>	○ <sup>*2</sup>
SDXC memory card	○ <sup>*1</sup>	○ <sup>*2</sup>
microSD memory card	○ <sup>*1</sup>	-
microSDHC memory card	○ <sup>*1</sup>	○ <sup>*2</sup>
microSDXC memory card	○ <sup>*1</sup>	○ <sup>*2</sup>

<sup>\*1</sup> SD speed class 4: **CLASS 4** or faster, or UHS speed class 1: **U1** or faster

<sup>\*2</sup> Memory cards that meet the following conditions

- Capacity of 4 GB or more

- SD speed class 10: **CLASS 10**, or UHS speed class 1: **U1** or faster

When recording in 100 Mbps or faster, UHS speed class 3: **U3** is required.

### Notes

- The movies recorded will be divided into files of 4GB when a SDHC memory card is used to record XAVC S movies over extended periods of time.  
The divided files will be played back continuously when played back on the camcorder.  
The divided files can be integrated into the single file by using PlayMemories Home.
  - Proper operation with all memory cards is not guaranteed. Contact the manufacturer of each memory card for the compatibility of memory cards other than Sony.
  - When using a Memory Stick Micro or microSD memory card with the camcorder, be sure to use it by inserting it into the dedicated adaptor.
  - Movies saved on SDXC memory cards cannot be imported to or played back on computers or AV devices not supporting the exFAT(\*) file system by connecting this product to these devices with the micro USB cable. Confirm in advance that the connecting equipment is supporting the exFAT system. If you connect equipment not supporting the exFAT system and a message that prompts you to perform formatting appears, do not perform the formatting. All the data saved will be lost.
- \* The exFAT is a file system that is used for SDXC memory cards.

## | To format the recording media

- To ensure stable operation of the memory card, it is recommended to format the memory card with your camcorder before the first use.
- To format the memory card, select **MENU** → [Setup] → [Media Settings] → [Format] → desired recording medium → **OK** .
- Formatting the memory card will erase all the data stored on it and the data will be irrecoverable. Save your important data on your PC, etc.

# Recording

## Recording movies

- 1 Open the LCD monitor, and press START/STOP to start recording.

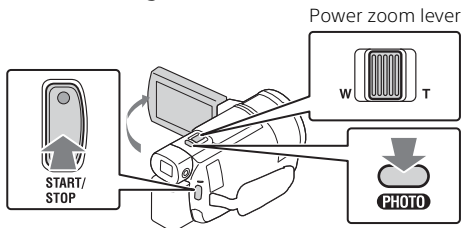

- To stop recording, press START/STOP again.
- Items on the LCD monitor disappear if you do not operate the camcorder for a few seconds. To display items again, touch anywhere except the buttons on the LCD monitor.

### Notes

- While recording movies in the XAVC S 4K 100Mbps or XAVC S 4K 60Mbps format, video signals (HDMI output signal/AV cable output signal) are not output to external media.

## To record MP4 movies simultaneously (Dual Video REC)

When [Dual Video REC] is set to [On], the camcorder records movies in MP4 format while recording movies in XAVC S 4K format, XAVC S HD format, or AVCHD format at the same time.

Select **[MENU]** → [Image Quality/Size] → [Dual Video REC] → desired setting.

- MP4 format is easy for playing back your movies on a smartphone, for uploading to a network, or for uploading to the Web.

## Recording photos during movie recording (Dual Capture)

You can record photos during movie recording by pressing PHOTO.

### Notes

- You may not be able to shoot photos depending on the setting in [ REC Mode ] and [ Frame Rate ].
- You cannot specify the storage destination (internal memory/memory card) of photos and movies separately (FDR-AX40/AX55/AXP55).

## To suppresses the voice of the person recording the movie (My Voice Canceling)

Press (My Voice Canceling) (page 53). The voice of the person recording the movie will be suppressed.

## Approximate recording time available

Movie format	Internal memory* <sup>1</sup>	Memory card* <sup>2</sup>
XAVC S 4K	2 h. 10 min.	64 GB: 2 h. 05 min.* <sup>3</sup>
XAVC S HD	2 h. 35 min.	64 GB: 2 h. 35 min.* <sup>4</sup>
AVCHD	8 h. 15 min.	16 GB: 2 h. 00 min.* <sup>5</sup>

\*<sup>1</sup> If you want to record up to the maximum recording time, you need to delete the demonstration movie on this product (FDR-AX40/AX55/AXP55).

\*<sup>2</sup> When using a Sony memory card.

\*<sup>3</sup> When recording with using the default setting:

[ File Format ]: [ XAVC S 4K ], [ REC Mode ]: [ 60Mbps ], [ Dual Video REC ]: [ Off ]

\*<sup>4</sup> Approximate recording time when recording with the following setting:  
[ File Format ]: [ XAVC S HD ], [ Frame Rate ]: [ 60p ]





\*<sup>5</sup> Approximate recording time when recording with the following setting:  
[ File format ]: [ AVCHD ], [ REC Mode ]: [ High Quality ]

- The actual recording time or number of recordable photos is displayed on the LCD monitor during recording.

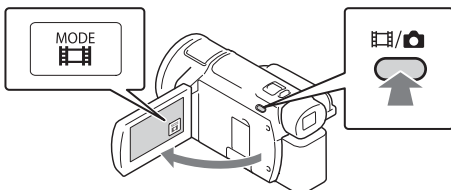
## Shooting photos

- 1 Open the LCD monitor and select [MODE] →  (Photo).



- You can also switch between  (Movie) and  (Photo) by pressing the / (Shooting Mode) button (FDR-AX53/AX55/AXP55).

- 2 Press PHOTO lightly to adjust the focus, then press it fully.

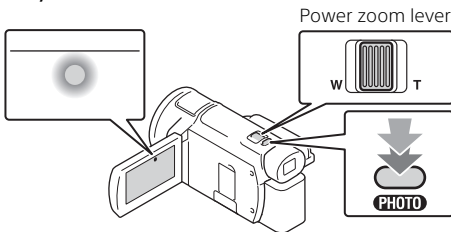

- When the focus is adjusted properly, AE/AF lock indicator appears on the LCD monitor.



# Using the manual adjustment features

## Assigning a menu item to the MANUAL ring (FDR-AX53/AX55/AXP55)

- 1 Press and hold MANUAL button (page 53) for a few seconds.
  - The menu items you can control with the MANUAL ring will appear on the [Manual Ring Setting] screen.

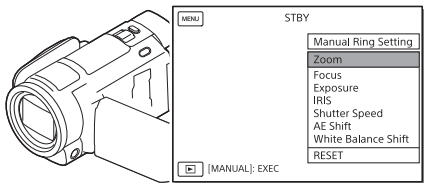

- 2 Rotate the MANUAL ring (page 53) to select the item to be assigned, and then press MANUAL button.

### Making the manual adjustment using the MANUAL ring



- ① Press the MANUAL button to switch to manual adjustment mode.
  - ② Rotate the MANUAL ring to make the adjustment.
- To return to automatic adjustment mode, press MANUAL button again.
  - When Zoom function is assigned, make the adjustment by only rotating the MANUAL ring.

# Playback

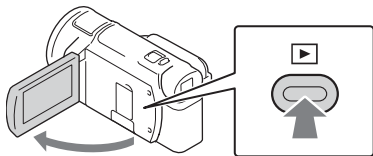
- 1 Open the LCD monitor and press the  (View Images) button on the camcorder to enter the playback mode.



- The Event View screen appears after some seconds.

- 2 Select  /  to move the desired event to the center, and then select the part circled (1) in the figure.

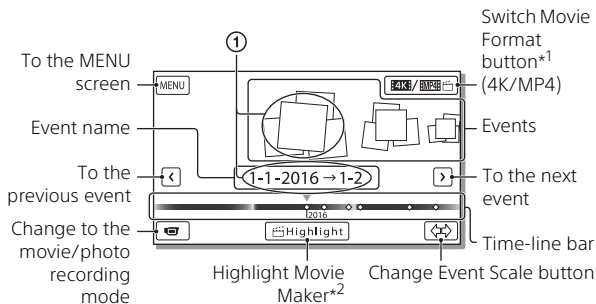

\*1 The icon varies depending on the [  File Format ] setting (page 28).

\*2 Highlight Movie Maker will be displayed when Movie format is set to AVCHD.

- Photos and movies are stored in the same recording medium (internal memory/memory card). (FDR-AX40/AX55/AXP55)
- To select the XAVC S movies or AVCHD movies you want to play, edit, or copy to other devices, select **[MENU]** → [Image Quality/Size] → [  File Format ].
- You can play movies of the selected frame rate only in the case of XAVC S 4K movies. Select the frame rate according to the movies you want to play.

### 3 Select the image.

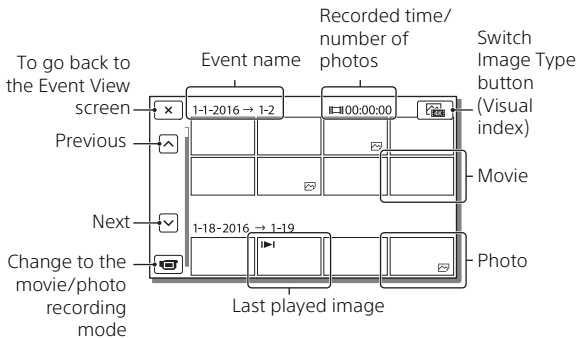

## | To switch between movies and photos (Visual index)

Select the desired type of images.

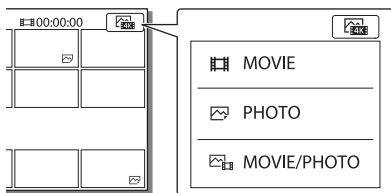

## | Playback operations

	Volume		Previous/Next
	Delete		Fast-reverse/Fast-forward
	Context		Play/Pause
	Stop		Play/Stop slide show
	Motion Shot Video		Motion Interval ADJ

## | To delete the images

- ① Select **MENU** → [Image Quality/Size] → [**File Format**] → format of images to be deleted.
  - The available format varies depending on the [**File Format**] setting.
- ② Select [Edit/Copy] → [Delete] → [Multiple Images] → image type to be deleted.
- ③ Touch and display the ✓ mark on the images to be deleted, then select **OK**.

## | Switching to MP4

- ① Select “Switch Movie Format button.”

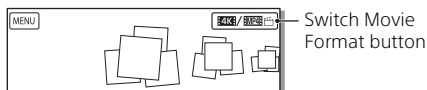

- The Movie Format Select screen appears.
- ② Select the format of the movie.

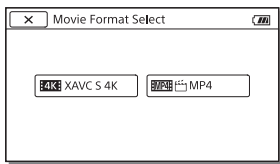

## | To copy the images from the internal memory to a memory card (FDR-AX40/AX55/AXP55)

- ① Select **MENU** → [Edit/Copy] → [Copy] → [Int. Memory → Memory card] → [Multiple Images].
- ② Select the image type to be copied.
- ③ Touch and display the ✓ mark on the images to be copied, then select **OK**.
- ④ Select **OK**.

### Notes

- XAVC S movies saved on the internal memory cannot be copied to SDHC memory cards or external media devices with the FAT file system.

# Viewing images on a TV

## Playing back images





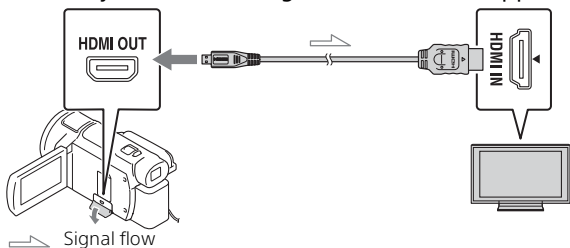







Playable images may be restricted depending on the combination of the movie format at the time of recording, the type of playback images selected on the Event View screen, and the HDMI output settings.

- 1 Connect the HDMI OUT jack of the camcorder to the HDMI IN jack of a TV using the HDMI cable supplied.



- 2 Set the input of TV to HDMI IN.
- 3 Play back images on the camcorder.

## | How to set the playback images

Movie format	TV	[HDMI Resolution]	Visual index (page 27)	Playback image quality
XAVC S 4K	4K TV	[Auto], [2160p/1080p]	 MOVIE  PHOTO  MOVIE/ PHOTO	4K image quality
		[1080p], [1080i], [720p]	 MOVIE  MOVIE/ PHOTO  PHOTO	High definition image quality (HD)
	High definition TV	[Auto], [1080p], [1080i], [720p]	 MOVIE  PHOTO  MOVIE/ PHOTO	High definition image quality (HD)
XAVC S HD AVCHD	4K TV or High definition TV	[Auto], [2160p/1080p], [1080p], [1080i], [720p]	 MOVIE  MOVIE/ PHOTO	High definition image quality (HD)
			 PHOTO	4K image quality (when connected to a 4K TV)*

\* The resolution will be the HDMI Resolution set on your camcorder.

- Images will be played when [HDMI Resolution] is set to [Auto] (default setting).
- If images are not played properly with [Auto], change the [HDMI Resolution] setting. Select **[MENU]** → [Setup] → [  Connection ] → [HDMI Resolution] → desired setting.
- If your TV does not have an HDMI jack, connect the Multi/Micro USB Terminal of the camcorder to the video/audio input jacks of the TV using an AV cable (sold separately).

## Connecting the camcorder to a network-compatible TV

Connect the camcorder to an access point with a security setting (page 41). Press  (View Images) on the camcorder, and then select **MENU** → [Wireless] → [Function] → [View on TV] → image type to be played back.

- You can view AVCHD movies, MP4 movies, and photos only.

## Playing back trimmed movies (Trimming Playback) recorded in XAVC S 4K format

You can play back the movies recorded in XAVC S 4K file format while magnifying and trimming the part you want to watch, and also while zooming the scene up to the full high definition image quality.

### 1 Change the HDMI output setting to output 4K movies.

Select **MENU** → [Setup] → [Connection] → [HDMI Resolution] → desired setting.

### 2 Connect the HDMI OUT jack of the camcorder to the HDMI IN jack of a TV using the HDMI cable supplied.

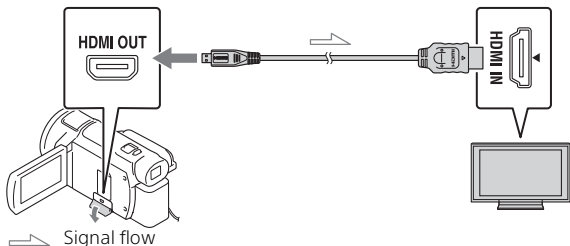

TV	[HDMI Resolution]
4K TV	[Auto]*, [2160p/1080p]*, [1080p], [1080i], [720p]
High definition TV	[Auto], [1080p], [1080i], [720p]

\* The screen turns blank for a few seconds when you turn on or off the trimmed movie playback function.

**3** Touch  (trimming on) on the LCD monitor during playback, and then select the part to be trimmed by touching there.

- The playback image is trimmed in high definition image quality (HD).

#### Notes

- Playback of trimmed movies is not available on the LCD monitor of the camcorder.



# Viewing images using the built-in projector (FDR-AXP55)

- 1 Press the PROJECTOR button (page 53).
- 2 Select [Image Shot on This Device].
- 3 Follow the operating guide on the LCD monitor, and then select [Project].

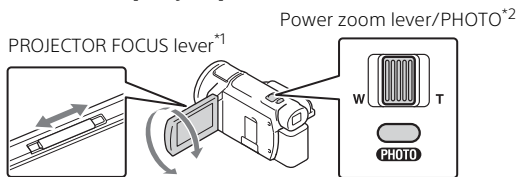

\*1 Adjust the focus of the projected image.

\*2 Use the power zoom lever to move the selection frame that appears on the projected image, then press the PHOTO button.

## Using the built-in projector with a computer/ smartphone

- ① Connect the PROJECTOR IN jack (page 53) of this product and the HDMI output terminal of the device you wish to connect by using an HDMI cable (supplied).
  - Use a commercially available plug adapter if the HDMI cable (supplied) does not fit with the terminal of the device you wish to connect to. For details, refer to the instruction manuals of the device you wish to connect to.
- ② Select [Image from External Device] in the Step 2 above.

# Importing images to your computer

## What you can do with PlayMemories Home™

PlayMemories Home allows you to import movies and photos to your computer to use them in a variety of ways.

- Update PlayMemories Home to the latest version before using.



Import images from the camcorder.

Playing back imported images



Sharing images on PlayMemories Online™



For Windows, the following functions are also available.



Viewing images on Calendar



Creating movie discs



Uploading images to network services

## | To download PlayMemories Home

PlayMemories Home can be downloaded from the following URL.

<http://www.sony.net/pm/>

## | To check the computer system

You can check the computer requirements for the software at the following URL.

<http://www.sony.net/pcenv/>



# Saving images on an external media device

How to store movies and photos to an external media device is explained here. Also refer to the instruction manual supplied with the external media device.

Store movies to a computer using PlayMemories Home software (page 34).

## How to store movies

Device	Cable	Image quality/ Recording format	Media
Recorder without a USB jack	AV cable (sold separately)	Standard definition image quality	DVD
External media device	VMC-UAM2 USB Adaptor Cable (sold separately)	4K/High definition image quality (HD) <ul style="list-style-type: none"><li>• XAVC S</li><li>• AVCHD</li></ul>	External media
Computer	Micro USB cable	4K/High definition image quality (HD) <ul style="list-style-type: none"><li>• XAVC S</li><li>• AVCHD</li></ul>	Computer and connected external media

- See the following website for the latest storage environment.  
<http://www.sony.net/>
- You can store images by connecting to a recorder with an analog AV cable (sold separately). Movies are copied with standard definition image quality (page 36).
- You can directly copy images to an external media device with the VMC-UAM2 USB Adaptor Cable (sold separately).

## How to connect a device

### | Recorder without a USB jack

Connect a recorder to the Multi/Micro USB Terminal of your camcorder using an AV cable (sold separately).

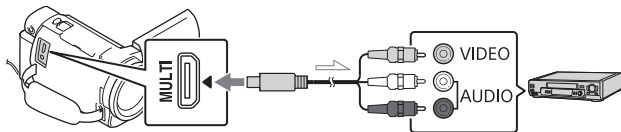

➤ Signal flow

- For how to save images, also refer to the instruction manual of your recording device.
- Movies are copied with standard definition image quality.

### | USB external hard disk

Connect an external media device to the Multi/Micro USB Terminal of your camcorder using VMC-UAM2 USB Adaptor Cable (sold separately).

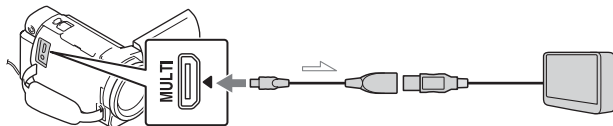

➤ Signal flow

- Movies are copied with 4K/high definition image quality (HD).

# Using the Wi-Fi function

## Installing PlayMemories Mobile™ on your smartphone

For the latest information and more detailed information on the functions of PlayMemories Mobile, visit the following URL.



<http://www.sony.net/pmm/>

### | Android OS

Install PlayMemories Mobile from Google Play.



- Android 4.0 or higher is required to use One-Touch functions (NFC).

### | iOS

Install PlayMemories Mobile from App Store.



- One-touch functions (NFC) are not available with iOS.

### Notes

- You may not be able to download PlayMemories Mobile from Google play or App Store depending on the country or the region. In that case, search for "PlayMemories Mobile".
- If PlayMemories Mobile is already installed in your smartphone, update the software to the latest version.
- The Wi-Fi function described here is not guaranteed to work on all smartphones and tablets.
- The Wi-Fi function of the camcorder cannot be used connected to a public wireless LAN.
- To use the One-touch functions (NFC) of the camcorder, a smartphone or tablet supporting the NFC function is required.
- The operation methods and display screens for the application are subject to change without notice by future upgrades.

## Transferring MP4 movies and photos to your smartphone

### One-touch connection with an Android supporting NFC

- 1 On the smartphone, select [Settings], then, select [More...] to check that [NFC] is enabled.

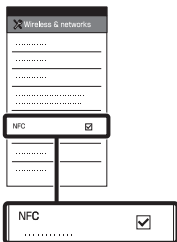

- 2 On the camcorder, play back an image to be sent to the smartphone.
  - You can transfer MP4 movies and photos only.
  - To select MP4 movies when you play back movies, see "Switching to MP4" (page 28).

- 3 Touch the camcorder to the smartphone.

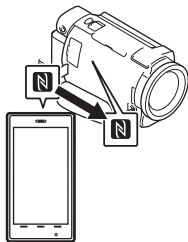

### Notes

- Cancel the sleep mode or unlock the screen on the smartphone beforehand.
- Make sure that **N** is displayed on the LCD monitor of the camcorder and the smartphone.
- Continue touching the camcorder to the smartphone without moving until PlayMemories Mobile starts (1 to 2 seconds).
- If the camcorder cannot be connected with the smartphone by NFC, see "Connecting to a Wi-Fi network using the QR Code" (page 38).

### Connecting to a Wi-Fi network using the QR Code

- 1 Press the **▶** (View Images) button, then select **MENU**  
→ [Wireless] → [Wi-Fi Function] → [Send to Smartphone] → [Select on This Device] → image type.

- 2 Select the image you want to transfer, and add ✓, and then select **OK** →

**OK** .

- The QR Code, SSID, and password are displayed.



- 3 Start up PlayMemories Mobile.

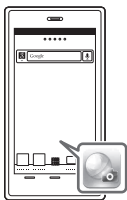

- 4 Select [Scan QR Code of the Camera] from the screen of PlayMemories Mobile.

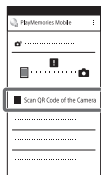

- 5 Select **[OK]**. (If a message appears, select **[OK]** again.)



- 6 With your smartphone, read the QR Code displayed on the LCD monitor of the camcorder.

### Android

Perform the following operations.

- When [Connect with the camera?] is displayed, select [Connect].

### iPhone/iPad

Perform the following operations.

- Follow the on-screen instruction and install the profile (setting information).

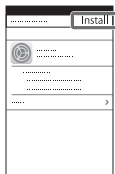

- ② On Home, select [Settings] → [Wi-Fi].

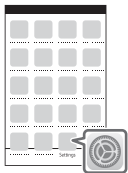

- ③ Select the SSID of the camcorder.



- ④ Go back to Home and start up PlayMemories Mobile.

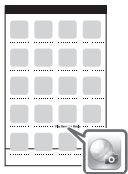

- Once the QR Code has read and the connection has been successfully established, the SSID (DIRECT-xxxx) and the password of the camcorder will be registered onto your smartphone. The subsequent Wi-Fi connection between the camcorder and your smartphone will only require selecting the SSID of the camcorder registered on your smartphone.

- If the camcorder cannot be connected with the smartphone by NFC and by reading the QR code, connect by using the SSID and the password. For more details, refer to "Help Guide".

## Using your smartphone as a wireless remote commander

You can record with the camcorder using your smartphone as a wireless remote commander.

- 1 On your camcorder, select **[MENU]** → **[Wireless]** → **[Wi-Fi Function]** → **[Ctrl with Smartphone]**.
- 2 On your smartphone, perform in the same way as in step 6 in "Connecting to a Wi-Fi network using the QR Code" (page 38).  
When you use NFC, display the recording screen on your camcorder, and touch **[N]** on the camcorder to **[N]** on the smartphone.
- 3 Operate the camcorder on your smartphone.

### Notes

- Depending on local electrical interference or the smartphone's capabilities, the live view images may not be displayed smoothly.



## Saving movies and photos to your computer via Wi-Fi

Connect your computer to a wireless access point or wireless broadband router in advance.

### 1 Install the dedicated software in your computer (first time only).

Windows: PlayMemories Home  
<http://www.sony.net/pm/>

Mac: Wireless Auto Import  
<http://www.sony.co.jp/imsoft/Mac/>

- If the software is already installed in your computer, update the software to the latest version.

### 2 Connect your camcorder to an access point as follows (first time only).

If you cannot register, refer to the instruction of the access point, or contact the person who set up the access point.

#### If the wireless access point has a WPS button

- ① On your camcorder, select **MENU** → [Wireless] → [Wi-Fi Setting] → [WPS Push].
- ② Press the WPS button on the access point you want to register.

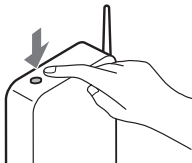

#### If you know the SSID and the password of your wireless access point

- ① On your camcorder, select **MENU** → [Wireless] → [Wi-Fi Setting] → [Access point settings].
- ② Select the access point you want to register, enter the password, then select [Next].

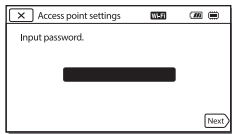

### 3 If your computer is not started, turn on the computer.

### 4 Start sending images from the camcorder to the computer.

- ① Press the  (View Images) button on your camcorder.
  - ② Select **MENU** → [Wireless] → [Wi-Fi Function] → [Send to Computer].
- Images are automatically transferred to and saved on the computer.
  - Only newly recorded images are transferred. Importing movies and multiple photos may take time.

# Using the menus

## 1 Select **MENU**.



## 2 Select a category.

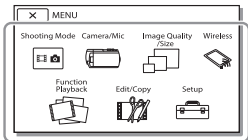

## 3 Select a desired menu item.

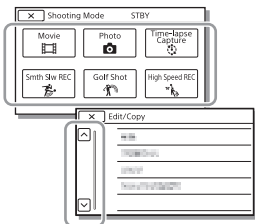

Scroll the menu items up or down.

- Select **X** to finish setting the menu or to return to the previous menu screen.

## Menu lists

### Shooting Mode

Movie

Photo

Time-lapse Capture

Smth Slw REC<sup>\*1</sup>

Golf Shot<sup>\*1</sup>

High Speed REC<sup>\*2</sup>

### Camera/Mic

#### Manual Settings

White Balance

Spot Meter/Fcs

Spot Meter

Spot Focus

Exposure

Focus

IRIS

Shutter Speed

AGC Limit

AE Shift

White Balance Shift

Low Lux

#### Camera Settings

Scene Selection

Picture Effect

 Cinematone

 Fader

 Self-Timer

 SteadyShot

 SteadyShot

Digital Zoom

Filter/Protector

Auto Back Light

Manual Ring Setting\*<sup>3</sup>

NIGHTSHOT Light\*<sup>3</sup>

 Face

Face Detection

Smile Shutter

Smile Sensitivity

 Flash\*<sup>4</sup>

Flash

Flash Level

Red Eye Reduction

 Microphone

My Voice Canceling

Blt-in Zoom Mic

Auto Wind NR

Audio Mode

Audio Rec Level

 Shooting Assist

My Button

Focus Magnifier\*<sup>3</sup>

Grid Line

Display Setting

Zebra

Peaking

Audio Level Display

 Image Quality/Size

 REC Mode

 Frame Rate

Dual Video REC



 File Format

 Image Size

 Wireless

 Function

Ctrl with Smartphone

Multi Camera Control

Live Streaming

Send to Smartphone

Send to Computer

View on TV

 Setting

Airplane Mode

Multi Camera Ctrl Set

Vid REC during strm.\*<sup>5</sup>

WPS Push

Access point settings

Edit Device Name

Disp MAC Address

SSID/PW Reset

Network Info Reset

 Playback Function

Event View

 Edit/Copy

Delete

Protect

Copy

Direct Copy\*<sup>6</sup>

 Setup

 Media Settings

Media Select\*<sup>7</sup>

Media Info

Format

Repair Img. DB F.

File Number

 Playback Settings

Data Code

Volume

Motion Interval ADJ

Download Music\*<sup>8</sup>

Empty Music\*<sup>8</sup>

**00:00** TC/UB

TC/UB Disp

TC Preset

UB Preset

TC Format<sup>\*9</sup>

TC Run

TC Make

UB Time Rec

↔ Connection

TV Type

HDMI Resolution

CTRL FOR HDMI

USB Connect

USB Connect Setting

USB LUN Setting

🔑 **General Settings**

Beep

Monitor Brightness

Auto Keystone ADJ<sup>\*10</sup>

REC Lamp

Remote Ctrl

Power ON w/monitor<sup>\*11</sup>

Language Setting

24p Mode<sup>\*12</sup>

Cancel 24p Mode<sup>\*12</sup>

Battery Info

Power Save

Initialize

Demo Mode

Version

🕒 **Clock Settings**

Date & Time Setting

Area Setting

<sup>\*2</sup> When image size is set to [XAVC S HD]

<sup>\*3</sup> FDR-AX53/AX55/AXP55

<sup>\*4</sup> You can set this item when you use a flash (sold separately).

<sup>\*5</sup> Live Streaming feature is dependent upon the Third Party Internet Provider's service and terms in your region. The feature may not be available due to your region's broadband and internet service restriction.

<sup>\*6</sup> You can set this item when you use an external media device (sold separately).

<sup>\*7</sup> FDR-AX40/AX55/AXP55

<sup>\*8</sup> The feature may not be available depending on the countries/regions.

<sup>\*9</sup> 1080 60i-compatible models

<sup>\*10</sup> FDR-AXP55

<sup>\*11</sup> FDR-AX40

<sup>\*12</sup> 1080 50i-compatible models

# Precautions

## AC Adaptor

Do not short-circuit the battery terminal with any metallic objects. This may cause a malfunction.

## Playing back images with other devices

You may not be able to play back images that were recorded on your camcorder with other devices normally. Also, you may not be able to play back images recorded on other devices with your camcorder.

## Recording and playback

- Avoid rough handling, disassembling, modifying, physical shock, or impact such as hammering, dropping or stepping on the product. Be particularly careful with the lens.
- To ensure stable operation of the memory card, it is recommended to format the memory card with your camcorder before the first use. Formatting the memory card will erase all the data stored on it and the data will be irrecoverable. Save your important data on your PC, etc.
- Confirm the direction of the memory card. If you forcibly insert the memory card in the wrong direction, the memory card, memory card slot, or image data may be damaged.
- Before starting to record, test the recording function to make sure the image and sound are recorded without any problems.

- Television programs, films, video tapes, and other materials may be copyrighted. Unauthorized recording of such materials may be a violation of the copyright laws.
- Compensation for the content of recordings cannot be provided, even if recording or playback is not possible due to a malfunction of the camcorder, recording media, etc.
- The camcorder is not dustproofed, dripproofed or waterproofed.
- Do not let your camcorder get wet, for example, from rain or sea water. If your camcorder gets wet, it may malfunction. Sometimes this malfunction cannot be repaired.
- Do not aim the camcorder at the sun or strong light. Doing so may cause your camcorder to malfunction.
- Do not use the camcorder near strong radio waves or radiation. The camcorder may not be able to record or play back images properly.
- Do not use the camcorder on a sandy beach or anywhere dusty. Doing so may cause your camcorder to malfunction.
- If moisture condensation occurs, stop using the camcorder until moisture evaporates.
- Do not subject the camcorder to mechanical shock or vibration. If you do so, the camcorder may operate incorrectly or may not record images. In addition, the recording medium or recorded data may be damaged.

## LCD monitor

The LCD monitor is manufactured using extremely high-precision technology, so over 99.99% of the pixels are operational for effective use. However, there may be some tiny black points and/or bright points (white, red, blue, or green in color) that appear constantly on the LCD monitor. These points are normal results of the manufacturing process and do not affect the recording in any way.

## Camcorder temperature

The camcorder and battery pack become warm during operation. This is not a malfunction.

## Overheat protection

Depending on the camcorder and battery temperature, you may be unable to record movies or the power may turn off automatically to protect the camcorder. A message will be displayed on the LCD monitor before the power turns off or you can no longer record movies. In this case, leave the power off and wait until the camcorder and battery temperature goes down. If you turn on the power without letting the camcorder and battery cool enough, the power may turn off again or you may be unable to record movies.

## Deactivating wireless LAN (Wi-Fi, NFC, etc.) temporarily

When you board an airplane, you can deactivate the Wi-Fi function temporarily. Select **[MENU]** → **[Wireless]** → **[ Setting]** → **[Airplane Mode]** → **[On]**.

## Wireless LAN

We assume no responsibility whatsoever for any damage caused by unauthorized access to, or unauthorized use of, destinations loaded on the camcorder, resulting from loss or theft.

## About the security on using Wireless LAN products

- Please ensure that you always use a secured wireless network with your devices to avoid hacking, unapproved third party access and other vulnerabilities.
- It is important to set security when using the wireless network function.
- Sony makes no guarantees and is not responsible for any damage resulting from having inadequate security or using the wireless network function.

## Troubleshooting

If you run into any problems using your camcorder:

- Check your camcorder referring to Help Guide (page 11).
- Disconnect the power source, attach the power source again after about 1 minute, and turn the camcorder on.
- Initialize your camcorder (page 44).  
All settings, including the clock setting, are reset.
- Contact your Sony dealer or local authorized Sony service facility.

# Specifications

## System

Signal format:

- UHDTV
- HDTV
- NTSC color, EIA standards (1080 60i-compatible models)
- PAL color, CCIR standards (1080 50i-compatible models)

Movie recording format:

- XAVC S (XAVC S format)
- Video: MPEG-4 AVC/H.264
- Audio: MPEG-4 Linear PCM 2ch (48 kHz/16 bit)
- AVCHD (AVCHD format Ver.2.0 compatible)
- Video: MPEG-4 AVC/H.264
- Audio: Dolby Digital 2ch/5.1ch
- Dolby Digital 5.1 Creator<sup>\*1</sup>
- MP4
- Video: MPEG-4 AVC/H.264
- Audio: MPEG-4 AAC-LC 2ch

<sup>\*1</sup> Manufactured under license from Dolby Laboratories.

Photo file format:

- DCF Ver.2.0 Compatible
- Exif Ver.2.3 Compatible
- MPF Baseline Compatible

Viewfinder (FDR-AX53/AX55/AXP55):

- 0.6 cm (0.24 type) Color
- 1 555 200 dots equivalent

Recording media (Movie/Photo):

- Internal memory (FDR-AX40/AX55/AXP55): 64 GB<sup>\*2</sup>
- XAVC S 4K (100Mbps), XAVC S HD High Speed REC (100Mbps),
- Movie:
  - SDHC memory card (UHS speed class 3 or faster)<sup>\*3</sup>
  - SDXC memory card (UHS speed class 3 or faster)<sup>\*3</sup>

microSDHC memory card (UHS speed class 3 or faster)<sup>\*3</sup>

microSDXC memory card (UHS speed class 3 or faster)<sup>\*3</sup>

XAVC S HD, XAVC S 4K (60Mbps), Movie:

SDHC memory card (Class 10, or UHS speed class 1 or faster)<sup>\*3</sup>

SDXC memory card (Class 10, or UHS speed class 1 or faster)<sup>\*3</sup>

microSDHC memory card (Class 10, or UHS speed class 1 or faster)<sup>\*3</sup>

microSDXC memory card (Class 10, or UHS speed class 1 or faster)<sup>\*3</sup>

AVCHD, Photo:

Memory Stick Micro (Mark2)

Memory Stick PRO-HD Duo

SD card (Class 4 or faster, or UHS speed class 1 or faster)

microSD memory card (Class 4 or faster, or UHS speed class 1 or faster)

<sup>\*2</sup> The capacity that a user can use (Approx.): 62.4 GB

1 GB equals 1 billion bytes, a portion of which is used for system management and/or application files. Only pre-installed demonstration movie may be deleted.

<sup>\*3</sup> Capacity of 4 GB or more is required.

Image device:

1/2.5-type (7.20 mm)

back-illuminated Exmor R™ CMOS sensor

Recording pixels (photo, 16:9):

Max. 16.6 mega pixels (5 440 × 3 056)<sup>\*4</sup>

Gross: Approx. 8.57 mega pixels

Effective (movie, 16:9)<sup>\*5</sup>:

Approx. 8.29 mega pixels  
Effective (photo, 16:9):  
Approx. 8.29 mega pixels  
Effective (photo, 4:3):  
Approx. 6.22 mega pixels

#### Lens:

ZEISS Vario-Sonnar T\* Lens  
20× (Optical)<sup>\*5</sup>, 4K: 30× (Clear  
Image Zoom, while recording  
movies)<sup>\*6</sup> HD: 40× (Clear Image  
Zoom, while recording  
movies)<sup>\*6</sup>, 250× (Digital)

Filter diameter:

55 mm (2 1/4 in.)

F2.0 - F3.8

Focal length:

f= 4.4 mm - 88 mm (3/16 in. -  
3 1/2 in.)

When converted to a 35 mm  
still camera

For movies<sup>\*5</sup>:

f=26.8 mm - 536 mm  
(1 1/16 in. - 21 1/8 in.) (16:9)

For photos:

f=26.8 mm - 536 mm  
(1 1/16 in. - 21 1/8 in.) (16:9)

Color temperature: [Auto], [One  
Push], [Indoor], [Outdoor]

Minimum illumination:

4K: 9 lx (lux), HD: 6 lx (lux) (in  
default setting, shutter speed  
1/60 second)

4K: 1.8 lx (lux), HD: 1.2 lx (lux)  
([Low Lux] is set to [On], shutter  
speed 1/30 second)

NightShot (FDR-AX53/AX55/  
AXP55): 0 lx (lux) (shutter  
speed 1/60 second)

<sup>\*4</sup> The unique image  
processing system of Sony's  
BIONZ-X allows still image  
resolution equivalent to the  
sizes described.

<sup>\*5</sup> [SteadyShot] is set to  
[Standard] or [Off].

<sup>\*6</sup> [SteadyShot] is set to  
[Active].

---

### Input/Output connectors

HDMI OUT jack: HDMI micro  
connector

PROJECTOR IN jack (FDR-AXP55):  
HDMI micro connector

MIC input jack: Stereo minijack  
( $\phi$ 3.5 mm)

Headphone jack: Stereo minijack  
( $\phi$ 3.5 mm)

USB jack: Multi/Micro USB  
Terminal\*

\* Supports Micro USB compatible  
devices.

USB connection is only for output  
(For customers in Europe).

---

### LCD monitor

Picture: 7.5 cm (3.0 type, aspect  
ratio 16:9)

Total number of pixels:

FDR-AX40:  
460 800 (960 × 480)

FDR-AX53/AX55/AXP55:  
921 600 (1 440 × 640)

---

### Projector (FDR-AXP55)

Projection type: DLP

Light source: LED (R/G/B)

Focus: Manual

Throw Distance: 0.5 m (1.6 feet) or  
over

Resolution (output): 854 × 480

Continuous projection time (when  
using the supplied battery pack):  
Approx. 2 h. 25 min.

---

### Wireless LAN

Supported standard:

IEEE 802.11 b/g/n

Frequency: 2.4 GHz



Supported security protocols:  
WEP/WPA-PSK/WPA2-PSK  
Configuration method: WPS (Wi-Fi  
Protected Setup)/manual  
Access method: Infrastructure  
Mode  
NFC: NFC Forum Type 3 Tag  
compliant

---

## General

Power requirements:  
DC 6.8 V/7.4V (battery pack),  
DC 8.4 V (AC Adaptor)  
USB Charging: DC 5 V 1 500 mA  
Average power consumption:  
During camera recording using  
the viewfinder (FDR-AX53/  
AX55/AXP55): 4K: 4.9 W,  
HD: 3.6 W\*  
During camera recording using  
LCD monitor at normal  
brightness: 4K: 4.9 W, HD:  
3.6 W\*  
\* in AVCHD FH mode  
Operating temperature: 0 °C to  
40 °C (32 °F to 104 °F)  
Storage temperature: -20 °C to  
+60 °C (-4 °F to +140 °F)  
Dimensions (approx.):  
FDR-AX40:  
73 mm × 80.5 mm × 142.5 mm  
(2 7/8 in. × 3 1/4 in. × 5 5/8 in.)  
(w/h/d) including the  
projecting parts  
73 mm × 80.5 mm × 166.5 mm  
(2 7/8 in. × 3 1/4 in. × 6 5/8 in.)  
(w/h/d) including the  
projecting parts, and the  
supplied rechargeable battery  
pack  
FDR-AX53/AX55:  
73 mm × 80.5 mm × 161.0 mm  
(2 7/8 in. × 3 1/4 in. × 6 3/8 in.)

(w/h/d) including the  
projecting parts  
73 mm × 80.5 mm × 166.5 mm  
(2 7/8 in. × 3 1/4 in. × 6 5/8 in.)  
(w/h/d) including the  
projecting parts, and the  
supplied rechargeable battery  
pack  
FDR-AXP55:  
77 mm × 80.5 mm × 161.0 mm  
(3 1/8 in. × 3 1/4 in. × 6 3/8 in.)  
(w/h/d) including the  
projecting parts  
77 mm × 80.5 mm × 166.5 mm  
(3 1/8 in. × 3 1/4 in. × 6 5/8 in.)  
(w/h/d) including the  
projecting parts, and the  
supplied rechargeable battery  
pack

Mass (approx.):

FDR-AX40:  
510 g (1 lb 2.0 oz) main unit  
only  
610 g (1 lb 5.5 oz) including the  
supplied rechargeable battery  
pack NP-FV70  
FDR-AX53/AX55:  
535 g (1 lb 2.9 oz) main unit  
only  
635 g (1 lb 6.4 oz) including the  
supplied rechargeable battery  
pack NP-FV70  
FDR-AXP55:  
565 g (1 lb 3.9 oz) main unit  
only  
660 g (1 lb 7.3 oz) including the  
supplied rechargeable battery  
pack NP-FV70

## | AC Adaptor AC-L200D

Power requirements: AC 100 V -  
240 V, 50 Hz/60 Hz  
Power consumption: 18 W  
Output voltage: DC 8.4 V\*

\* See the label on the AC Adaptor for other specifications.

## Rechargeable battery pack NP-FV70

Maximum output voltage: DC 8.4 V

Output voltage: DC 6.8 V

Maximum charge voltage: DC 8.4 V

Maximum charge current: 3.0 A



Capacity

Typical: 14.0 Wh (2 060 mAh)

Minimum: 13.3 Wh (1 960 mAh)

Type: Li-ion

## Trademarks

- AVCHD, AVCHD Progressive, AVCHD logotype and AVCHD Progressive logotype are trademarks of Panasonic Corporation and Sony Corporation.
- XAVC S and  are registered trademarks of Sony Corporation.
- Memory Stick and  are trademarks or registered trademarks of Sony Corporation.
- Blu-ray Disc™ and Blu-ray™ are trademarks of the Blu-ray Disc Association.
- Dolby and the double-D symbol are trademarks of Dolby Laboratories.
- The terms HDMI and HDMI High-Definition Multimedia Interface, and the HDMI Logo are trademarks or registered trademarks of HDMI Licensing LLC in the United States and other countries.

- Windows is either registered trademark or trademark of Microsoft Corporation in the United States and/or other countries.
- Mac is a registered trademark of Apple Inc. in the United States and other countries.
- Intel, Pentium and Intel Core are trademarks of Intel Corporation in the U.S. and/or other countries.
- SDXC logo is a trademark of SD-3C, LLC.
- Android and Google Play are trademarks of Google Inc.
- Wi-Fi, the Wi-Fi logo, Wi-Fi PROTECTED SET-UP are registered trademarks of the Wi-Fi Alliance.
- The N Mark is a trademark or registered trademark of NFC Forum, Inc. in the United States and in other countries.
- Facebook and the “f” logo are trademarks or registered trademarks of Facebook, Inc.
- YouTube and the YouTube logo are trademarks or registered trademarks of Google Inc.
- iPhone and iPad are trademarks of Apple Inc., registered in the U.S. and other countries.
- QR Code is registered trademark of DENSO WAVE INCORPORATED.

All other product names mentioned herein may be the trademarks or registered trademarks of their respective companies. Furthermore, ™ and ® are not mentioned in each case in this manual.

## | On GNU GPL/LGPL applied software

The software that is eligible for the following GNU General Public License (hereinafter referred to as "GPL") or GNU Lesser General Public License (hereinafter referred to as "LGPL") are included in this product.

This informs you that you have a right to have access to, modify, and redistribute source code for these software programs under the conditions of the supplied GPL/LGPL.

Source code is provided on the web.

Use the following URL to download it.

<http://oss.sony.net/Products/Linux>



We would prefer you do not contact us about the contents of source code.

Copies of the licenses (in English) are stored in the internal memory of this product. Establish a Mass Storage connection between this product and a computer, and read the files in the "LICENSE" folder in "PMHOME."

# Parts and controls

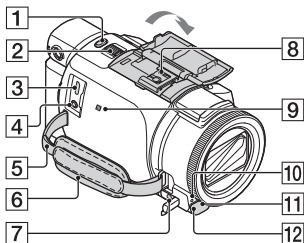
Figures in ( ) are reference pages.



- 1** PHOTO button (22, 24)
- 2** Power zoom lever (24)
- 3** Multi/Micro USB Terminal  
Supports Micro USB compatible devices. This terminal does not support VMC-AVM1 Adaptor Cable (sold separately). You cannot use accessories via an A/V remote connector.
- 4**  (microphone) jack (PLUG IN POWER)
- 5** Loop for a shoulder belt
- 6** Grip belt
- 7**  (headphones) jack
- 8** Multi interface shoe



For details on compatible accessories of the Multi interface shoe, visit the Sony web site in your area, or consult your Sony dealer or local authorized Sony service facility.

Operations with other manufacture's accessories are not guaranteed.

If you use a shoe adaptor (sold separately), you can also use

accessories compatible with an Active Interface Shoe.

To prevent failure, do not use a commercially available flash with high-voltage synchro terminals or with reverse polarity.

- 9** N mark (38)
- NFC: Near Field Communication
- 10** Camera recording lamp
- 11** Remote sensor
- 12** NIGHTSHOT light (FDR-AX53/AX55/AXP55)

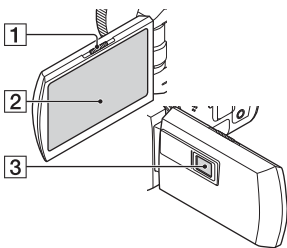

- 1** PROJECTOR FOCUS lever (33) (FDR-AXP55)
- 2** LCD monitor/Touch panel
- 3** Projector lens (FDR-AXP55)

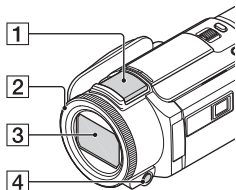

- 1** Built-in microphone
- 2** MANUAL ring (FDR-AX53/AX55/AXP55) (25)  
Manual functions can be assigned to the button and the dial.
- 3** Lens (ZEISS lens)
- 4** MANUAL button (FDR-AX53/AX55/AXP55)

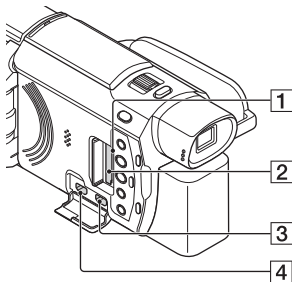

- 1** Memory card access lamp (19)
- 2** Memory card slot (19)
- 3** HDMI OUT jack
- 4** PROJECTOR IN jack (33) (FDR-AXP55)

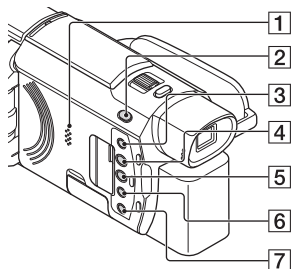

- 1** Speaker
- 2** (Shooting Mode) button (24) (FDR-AX53/AX55/AXP55)
- 3** (My Voice Canceling) button  
Suppresses the voice of the person recording the movie.
- 4** PROJECTOR button (33) (FDR-AXP55)
- 5** (View Images) button (26)
- 6** NIGHTSHOT button (FDR-AX53/AX55/AXP55)
- 7** (ON/STANDBY) button

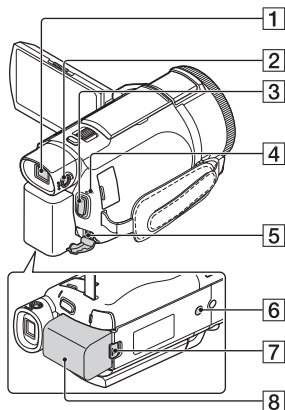

## | To fasten the grip belt

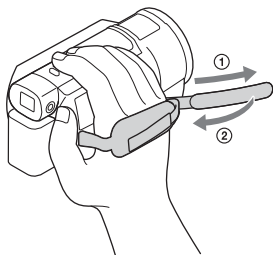

### **1** Viewfinder (FDR-AX53/AX55/AXP55)

The camcorder is turned on when the viewfinder is pulled out.

### **2** Viewfinder lens adjustment dial (FDR-AX53/AX55/AXP55)

If the indications in the viewfinder appear blurred, turn the viewfinder lens adjustment dial.

### **3** START/STOP button (22)

### **4** POWER/CHG (charge) lamp (15)

### **5** DC IN jack

### **6** Tripod receptacle

Attach a tripod (sold separately): the length of the screw must be less than 5.5 mm (7/32 in.). Depending on the specifications of the tripod, this product may not attach in the proper direction.

### **7** BATT (battery) release lever

### **8** Battery pack (15)

# Index

## A

- AC Adaptor 15
- Android 37
- App Store 37
- Assigning a menu item 25
- AVCHD 12, 13

## B

- Battery pack 15
- Beep 18

## C

- Charging the battery pack 15
- Charging the battery using your computer 16
- Charging time 16
- Computer 34
- Computer system 34

## D

- Date and time 18
- Delete 28
- Dual Video REC 22

## E

- Edit 26

## F

- Format 21
- Full charge 16

## G

- Google play 37
- Grip belt 54

## H

- HDMI cable 29
- Help Guide 11

## I

- Importing images to your computer 34
- Install 37

iOS 37

## L

- LCD monitor 52

## M

- Manual recording 25
- Memory card 19
- Memory Stick Micro™ (M2) media 19
- Menu lists 42
- Menus 42
- Micro USB cable 16
- microSD memory card 20
- Movies 22
- MP4 38
- My Voice Canceling 23

## N

- Network 31
- NFC 38

## O

- One-Touch functions (NFC) 37

## P

- Photos 24
- Playback 26
- PlayMemories Home 34
- PlayMemories Online 34
- Power on 18
- Precautions 45
- Projector 33

## R

- Recording 22
- Recording media 21
- Recording time 23
- Recording/playback time 16

## S

- Smartphone 37
- Software 34
- Specifications 47

Supplied items 14

## **T**

Touch panel 52

Trimming Playback 31

Tripod 54

Troubleshooting 46

TV 29

## **W**

Wall outlet (wall socket) 16

Wi-Fi 37

Windows 34

Wireless access point 41

## **X**

XAVC S 4K 12, 13

XAVC S HD 12, 13

## **Z**

Zoom 22









Additional information on this product and answers to frequently asked questions can be found at our Customer Support Website.

**<http://www.sony.net/>**

